

SECTION A-A
SCALE 1 : 1

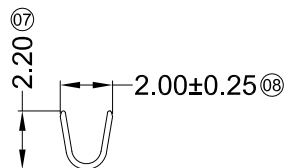

SECTION B-B
SCALE 1 : 1

Specifications :

- Voltage rating: 250V AC / DC
- Current rating: 5A AC / DC
- Withstanding voltage: 1500V AC/minute
- Temperature range: -25°C~+85°C
- Insulation resistance: ≥1000MΩ
- Contact resistance: ≤10mΩ
- After environmental testing: ≤20mΩ

X7725 T M-X SN X-X

- ① Series Number
- ② Category: T-terminal
- ③ Shape: M-Male
- ④ Material: P-Phosphor bronze B-Brass
- ⑤ Plating style:
SN-Bright tin plating 70u"
- ⑥ Plating method:
Blank-Stamping before plating
B-Plating before stamping
- ⑦ Mold No./Mark/Special No.

X7725TM-BSN	Brass	AWG#20-24	1.85mm(Max)	Stamping Before Plating:30-50u" Ni70-120u"Sn	X7725HF
X7725TM-PSN	Phosphor Bronze				
PART NO	Material	Wire Range	Insulation O.D.	Finish	Suitable XKB Terminal

For and on behalf of
XKB INDUSTRIAL PRECISION CO., LIMITED
香港星坤工業精密有限公司

△ X					ANGULAR	±5°
△ X					L ≤ 4	±0.2
△ X					4 < L ≤ 16	±0.3
△ X					16 < L ≤ 63	±0.4
MARK	DESCRIPTION	DATE	REVISED	APPROVED	L > 63	±0.5

REVISIONS
Authorized Signature(s)

UNSPECIFIED TOLERANCES

DSND		DATE		SCALE: N/A	MODEL TYPE: X7725TM-XSN
DWN		DATE		VIEW:	PART NO.: 1.58 mm Crimp Style Connectors
CHKD		DATE		UNIT: mm	DWG NO.:
APPD		DATE		SIZE: A4	

XKB INDUSTRIAL PRECISION CO., LIMITED

WEIGHT	SHEET	REVISION
1.0g	1/1	A0

Specifications :

- Voltage rating: 250V AC / DC
- Current rating: 5A AC / DC
- Withstanding voltage: 1500V AC/minute
- Temperature range: -25°C~+85°C
- Insulation resistance: ≥1000MΩ
- Contact resistance: ≤10mΩ
- After environmental testing: ≤20mΩ

X7725 T F-X SN X-X

- ① ② ③ ④ ⑤ ⑥ ⑦
- ① Series Number
 - ② Category: T-terminal
 - ③ Shape: F-Female
 - ④ Material: P-Phosphor bronze B-Brass
 - ⑤ Plating style:
SN-Bright tin plating
 - ⑥ Plating method:
Blank-Stamping before plating
B-Plating before stamping
 - ⑦ Mold No./Mark/Special No.

X7725TF-BSNB	Brass	AWG#20-24	1.85mm(Max)	Plating Before stamping:10~30u" Ni:40~60u"Sn	7725HM
X7725TF-BSN				Stamping Before Plating:30~50u" Ni:70~120u"Sn	
X7725TF-PSN	Phosphor Bronze				
PART NO	Material	Wire Range	Insulation O.D.	Finish	Suitable XKB Terminal

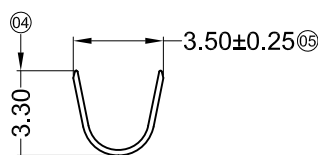
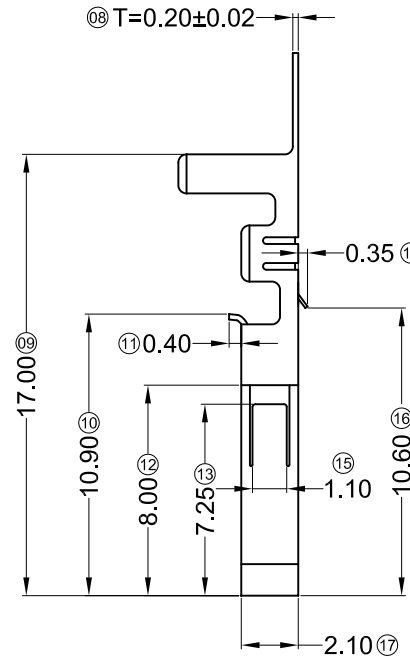
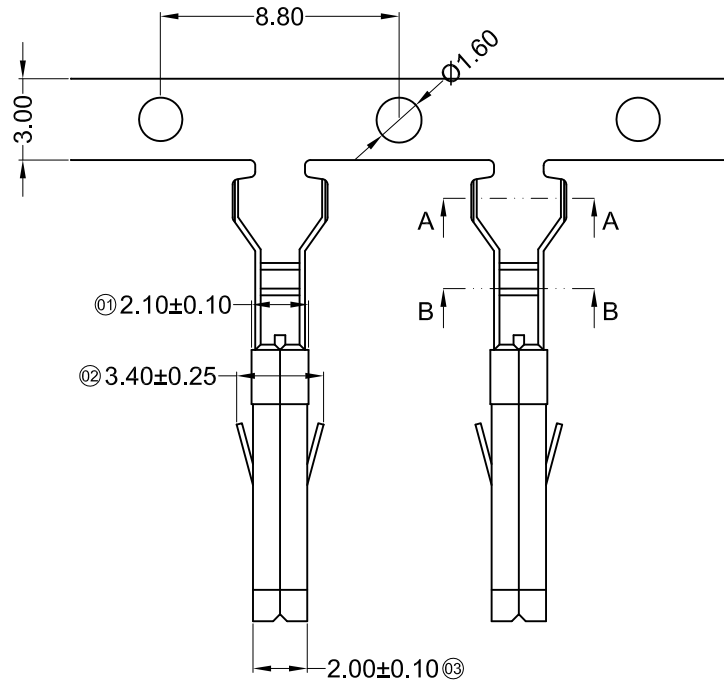

SECTION A-A
SCALE 1 : 1

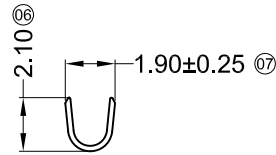

SECTION B-B
SCALE 1 : 1

For and on behalf of
XKB INDUSTRIAL PRECISION CO., LIMITED
香港星坤工業精密有限公司

△ X					ANGULAR	±5°
△ X					L ≤ 4	±0.2
△ X					4 < L ≤ 16	±0.3
△ X					16 < L ≤ 63	±0.4
MARK	DESCRIPTION	DATE	REVISED	APPROVED	L > 63	±0.5
REVISIONS					UNSPECIFIED TOLERANCES	

DSND		DATE		SCALE: N/A	MODEL TYPE:		
DWN		DATE		VIEW:	X7725TF-XSNX		
CHKD		DATE		UNIT: mm	1.58 mm CrImp Style Connectors		
APPD		DATE		SIZE: A4	DWG NO.:		
Authorized Signature(s)				XKB INDUSTRIAL PRECISION CO., LIMITED	WEIGHT	SHEET	REVISION
					1.0g	1/1	A0

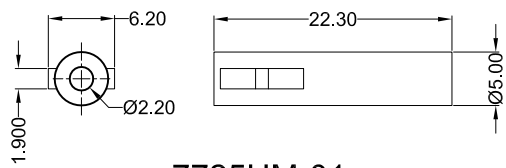

7725HM-01

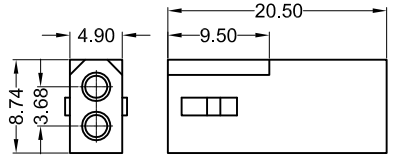

7725HM-1*02

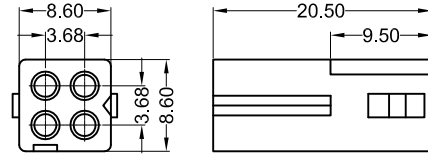

7725HM-2*02

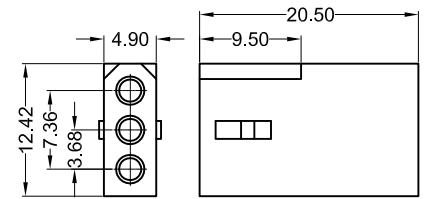

7725HM-1*03

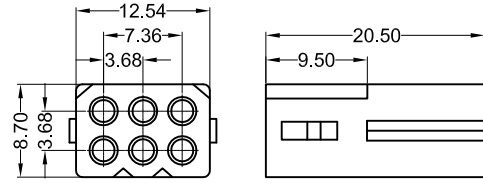

7725HM-2*03

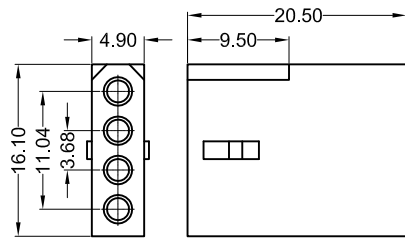

7725HM-1*04

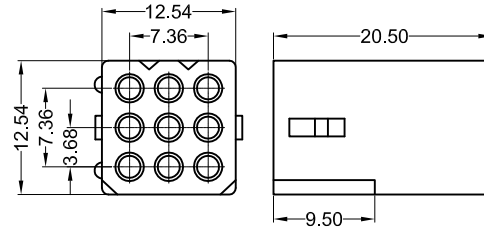

7725HM-3*03

■ Specifications :

- Voltage rating: 250V AC / DC
- Current rating: 5A AC / DC
- Withstanding voltage: 1500V AC/minute
- Temperature range: -25°C~+85°C
- Insulation resistance: ≥1000MΩ
- Contact resistance: ≤10mΩ
- After environmental testing: ≤20mΩ

X7725 H M-X*XX X-N2 XX

- ① ② ③ ④ ⑤ ⑥ ⑦

- ① Series No.
- ② Category: H-HSG
- ③ Welding Board Angle:
M-Male HSG
- ④ Row No.-Pin No.:
1*XX-Single Row
2*XX-Double Row
3*XX-Three Row
- ⑤ Plug the Pin & special No.:
- ⑥ Material: N2-PA66 94V-2
- ⑦ Color: Blank-natural color

X7725HM-3*XX-N2				Triple Row
X7725HM-2*XX-N2	Nylon 66 UL 94V-2	7725TF	7725HF	Dual Row
X7725HM-1*XX-N2				Single Row
PART NO	Material	Suitable XKB Terminal	Suitable XKB Terminal	Note

For and on behalf of
XKB INDUSTRIAL PRECISION CO., LIMITED
 香港星坤工業精密有限公司

△ X					ANGULAR	±5°	DSND		DATE	SCALE: N/A	MODEL TYPE: X7725HM-X*XX-N2		
△ X					L ≤ 4	±0.2	DWN		DATE	VIEW:	PART NO.:		
△ X					4 < L ≤ 16	±0.3	CHKD		DATE	UNIT: mm	1.58 mm Crimp Style Commtctors		
△ X					16 < L ≤ 63	±0.4	APPD		DATE	SIZE: A4	DWG NO.:		
MARK	DESCRIPTION	DATE	REVISED	APPROVED	L > 63	±0.5							
REVISIONS						UNSPECIFIED TOLERANCES	XKB INDUSTRIAL PRECISION CO., LIMITED				WEIGHT	SHEET	REVISION
											1.0g	1/1	A0

Authorized Signature(s)

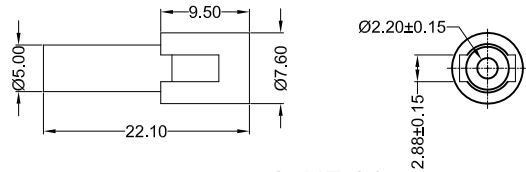

7725HF-01

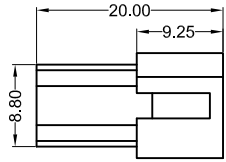

7725HF-1*02

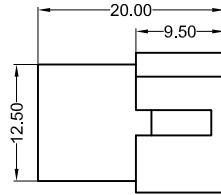
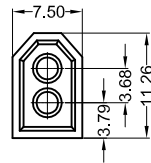

7725HF-1*03

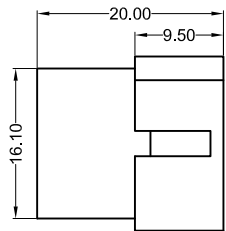
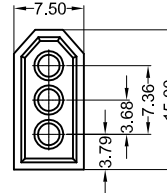

7725HF-1*04

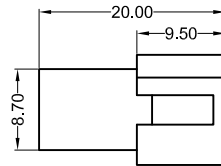
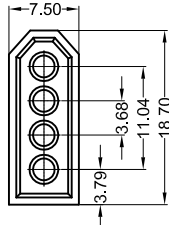

7725HF-2*02

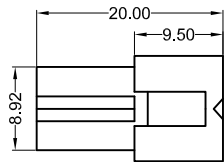
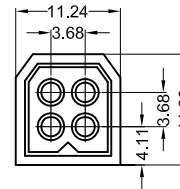

7725HF-2*03

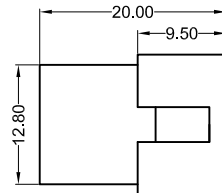
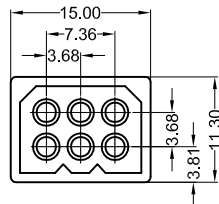

7725HF-3*03

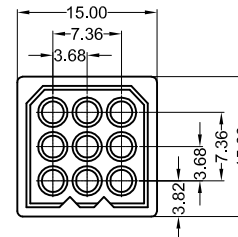

■ Specifications :

- Voltage rating: 250V AC / DC
- Current rating: 5A AC / DC
- Withstanding voltage: 1500V AC/minute
- Temperature range: -25°C~+85°C
- Insulation resistance: ≥1000MΩ
- Contact resistance: ≤10mΩ
- After environmental testing: ≤20mΩ

X7725 H F-X*XX X-N2 XX

① ② ③ ④ ⑤ ⑥ ⑦

- ① Series No.
- ② Category: H-HSG
- ③ Welding Board Angle:
F-Female HSG
- ④ Row No.-Pin No.:
1*XX-Single Row
2*XX-Double Row
3*XX-Three Row
- ⑤ Plug the Pin & special No.:
- ⑥ Material: N2-PA66 94V-2
- ⑦ Color: Blank-natural color

X7725HF-3*XX-N2	Nylon 66 UL 94V-2	7725TM	7725HM	Triple Row
X7725HF-2*XX-N2				Dual Row
X7725HF-1*XX-N2				Single Row
PART NO	Material	Suitable XKB Terminal	Suitable XKB Terminal	Note

For and on behalf of
XKB INDUSTRIAL PRECISION CO., LIMITED
 香港星坤工業精密有限公司

△ X					ANGULAR	± 5°
△ X					L ≤ 4	± 0.2
△ X					4 < L ≤ 16	± 0.3
△ X					16 < L ≤ 63	± 0.4
MARK					L > 63	± 0.5

REVISIONS
 Authorized Signature(s)

DSND		DATE		SCALE: N/A	MODEL TYPE: X7725HF-X*XX-N2	
DWN		DATE		VIEW:	PART NO.:	
CHKD		DATE		UNIT: mm	1.58 mm Crimp Style Commctors	
APPD		DATE		SIZE: A4	DWG NO.:	
				WEIGHT	SHEET	REVISION
				1.0g	1/1	A0

XKB INDUSTRIAL PRECISION CO., LIMITED